

PRZEKRÓJ A-A

pojemność 258 l

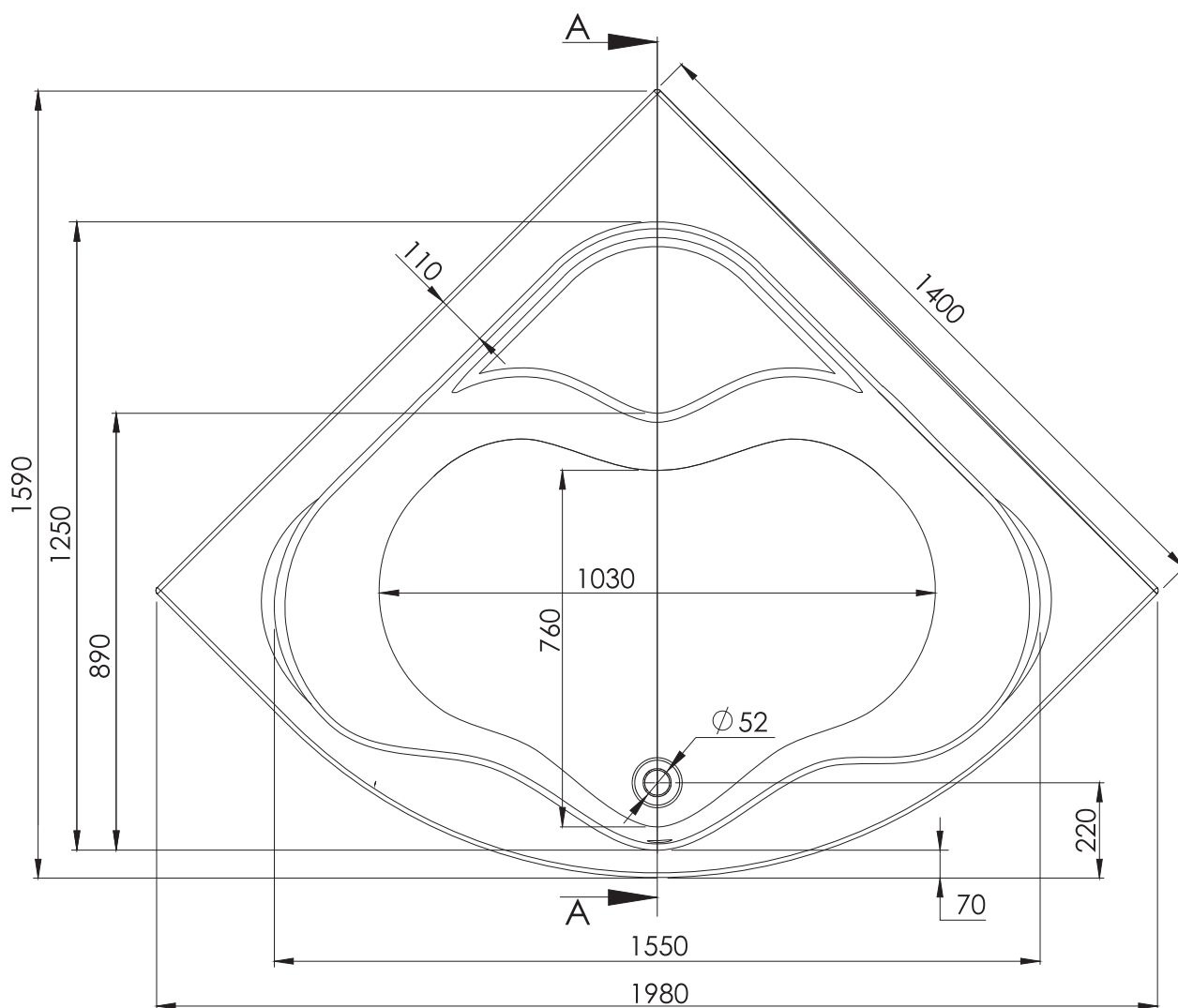

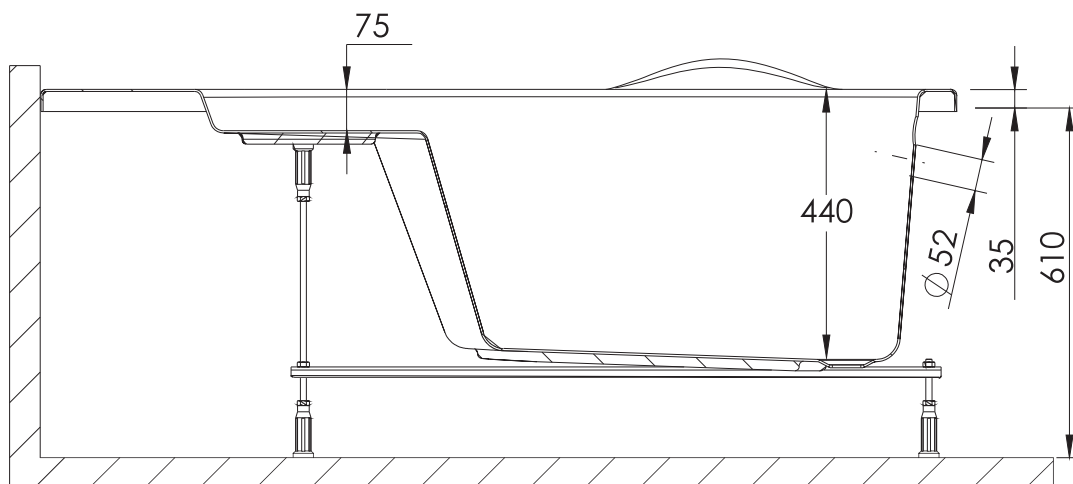

PRZEKRÓJ A-A

pojemność 275 l

